

*'No longer possible to simply
continue along previous lines':*

Cultivating flexible,
transversal engagement
in intersecting processes
of social and scientific change

Peter Taylor

Science in a Changing World graduate track
University of Massachusetts Boston

<http://bit.ly/CES12PT>

**“I made the wrong turn 30
years ago”**

*How can we reduce our
vulnerability to staying too
long with our chosen path of
research?*

“We couldn’t know how this technology would be used, so I pulled back.”

“Other knowledges are possible.”

Two ideals:
flexible engagement, transversal engagement

Three vignettes:
socio-environmental studies
social studies of mental illness
social studies of scientific knowledge

-> alternative path from Latour (1987):
interdisciplinary workshops etc.
for “refractive practice”

refractive practice

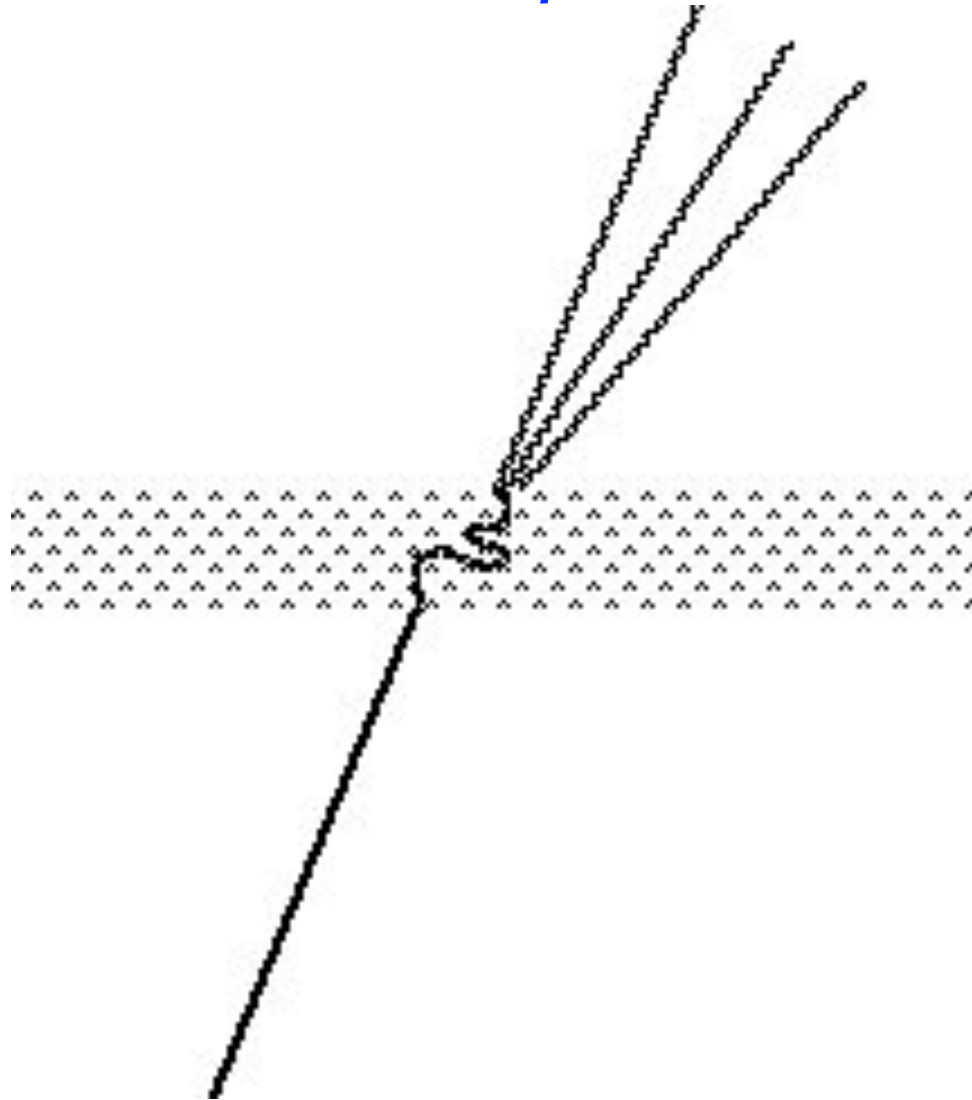

refractive practice

Principle 1:

Participants always bring a lot of knowledge about the topic of the session -> allow that to be brought to surface & acknowledged.

Principle 2:

What you really learn from a workshop or participatory experience is what you integrate with your own concerns.

refractive practice

Principle 1:

Participants always bring a lot of knowledge about the topic of the session -> allow that to be brought to surface & acknowledged.

Principle 2:

What you really learn from a workshop or participatory experience is what you integrate with your own concerns.

Guided Freewriting

Share one idea with a neighbour

Guided (topic-based) freewriting is an exercise designed to clear mental and/or emotional space and to allow ideas about an issue to begin to come to the surface before you simply push ahead.

In a freewriting exercise, you should not take your pen off the paper. Keep writing even if you find yourself stating over and over again, "I don't know what I'm expected to say." What you write will not be shown to anyone else, so do not go back to tidy up sentences, grammar, spelling. You will probably diverge from the topic, at least for a time while you acknowledge other preoccupations. That's OK- one of the purposes of the exercise is to express what is distracting you is. However, if you keep writing and do not stop for seven to ten minutes, you should expose some thoughts about the topic that had been below the surface of your attention-that is another of the aims of the exercise. There is no expectation about how much gets clear in this exercise-there will be plenty of time yet and opportunities for being stimulated by others.

Reference: Elbow, P. 1981. Writing with Power. New York: Oxford U. P.

Continue (in your preferred language) where this sentence leaves off:

"When I think about the path of research I am moving into at CES and I think about the long-term implications of such research, what do I think (or feel) about the possibility that I may look back and regret the choice or see that I stayed too long on this path?"

Three vignettes:

socio-environmental studies

social studies of mental illness

social studies of scientific knowledge

Marta María Barros · Luis María Barros
Elena Álvarez-Buylla

Lagunas

deterioro ambiental
y tecnología en el
campo semiproletariado

EL TERCER MUNDINO

Changes in

political-economics, environment, population
health & science

can be seen as the outcome of *intersecting
processes*

operating across different spatial and
temporal scales,
transgressing the boundaries of the
situation under consideration &
restructuring its "internal" dynamics.

Changes in

political-economics, environment, population
health & science

can be seen as the outcome of *intersecting
processes*

operating across different spatial and
temporal scales,
transgressing the boundaries of the
situation under consideration &
restructuring its "internal" dynamics.

Analysis of such processes exposes diverse
sites of engagement.

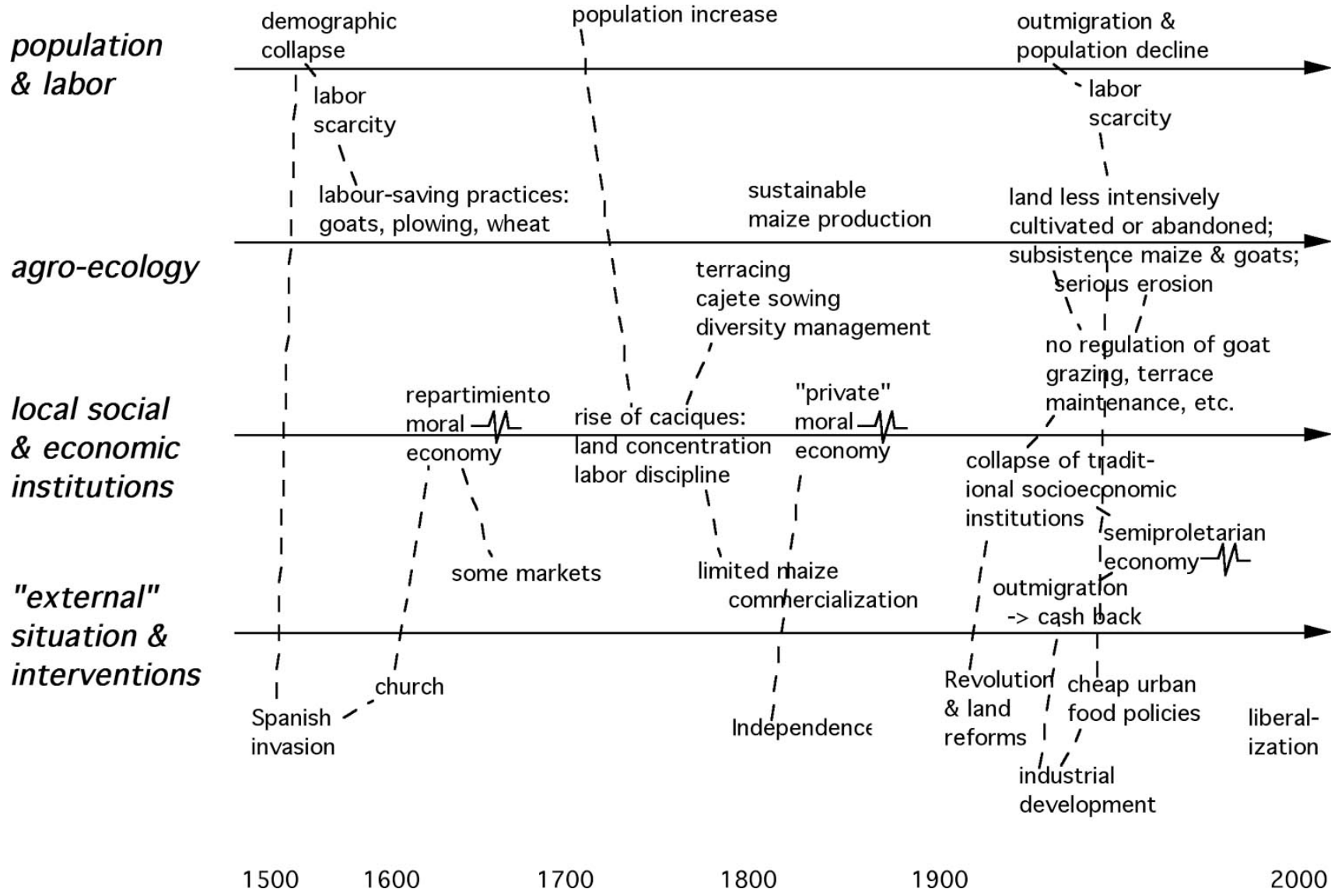

psychology

family

class

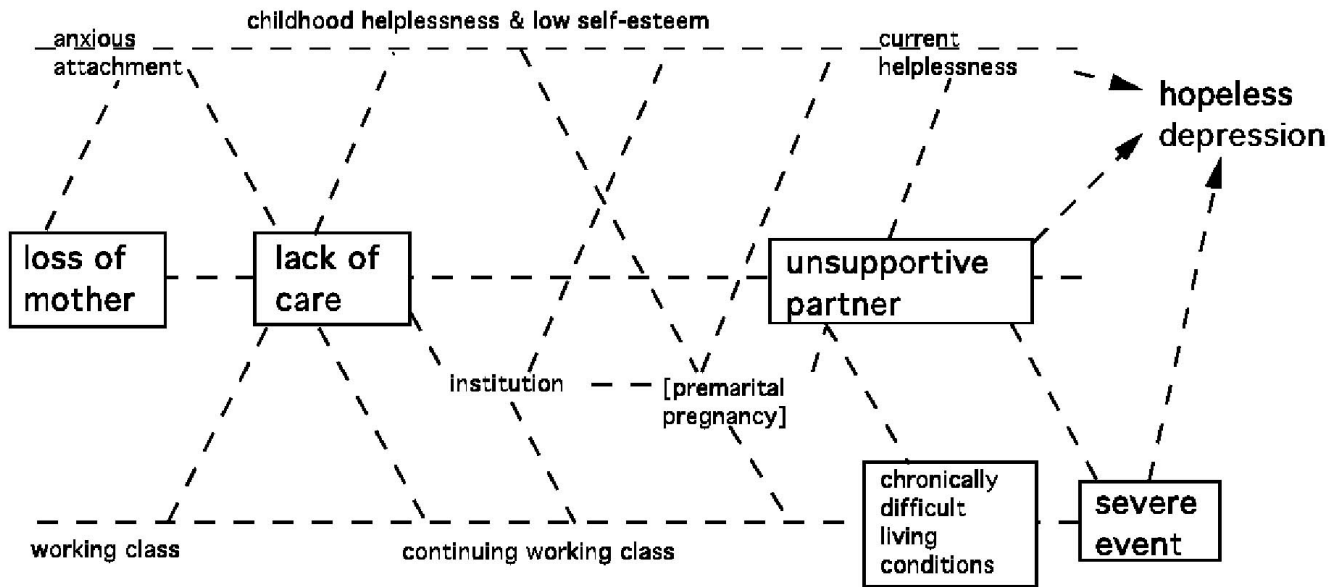

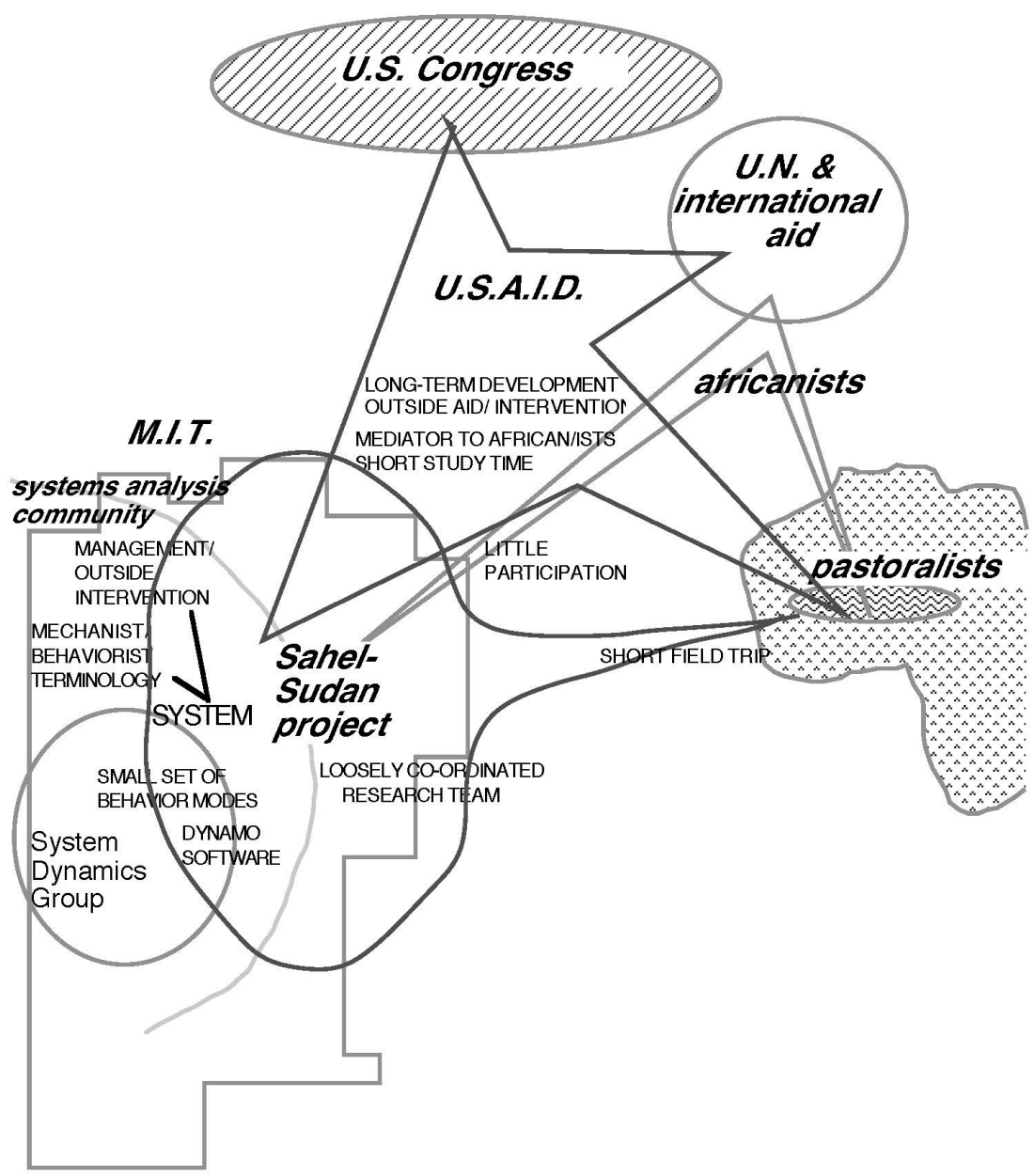

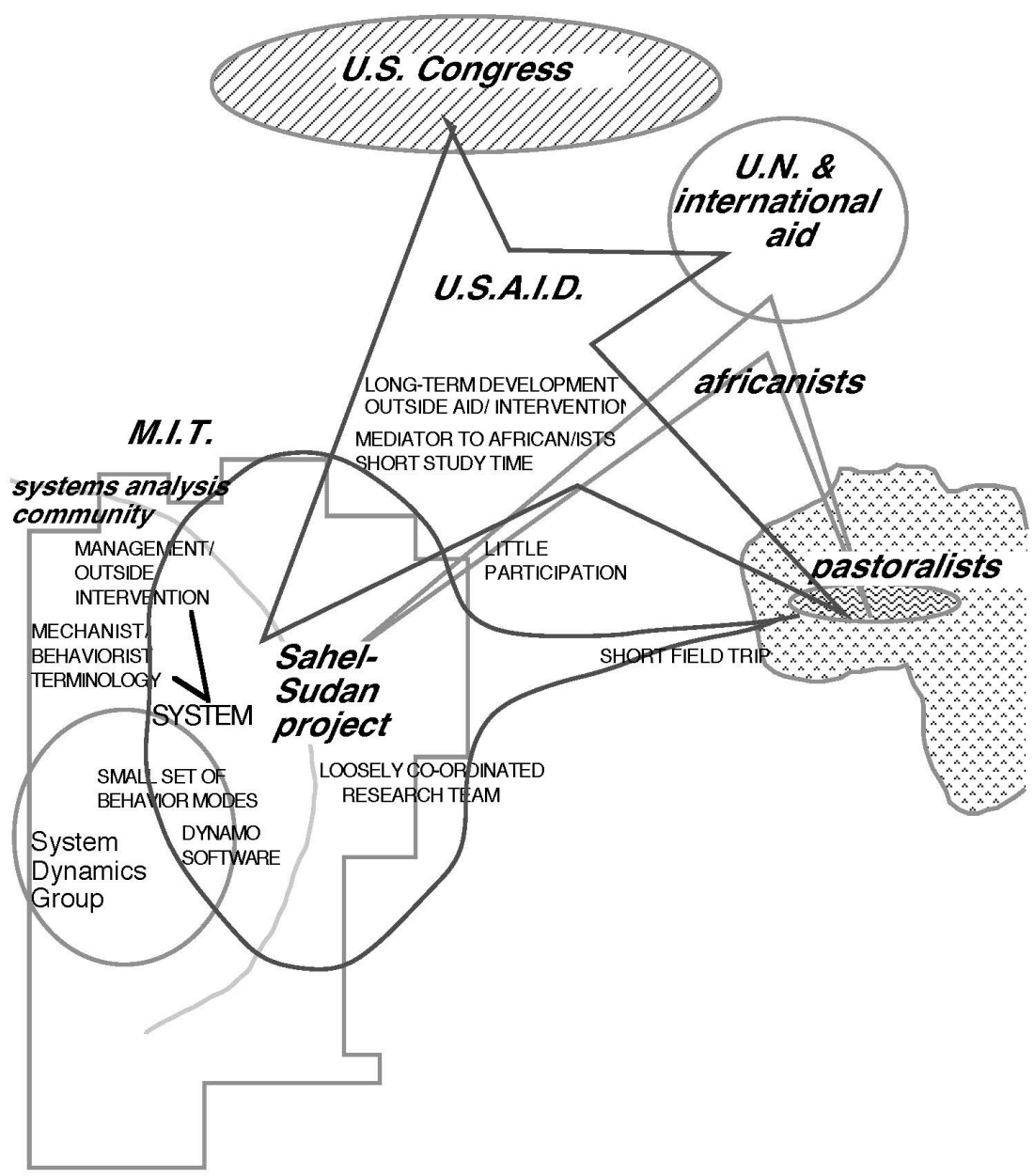

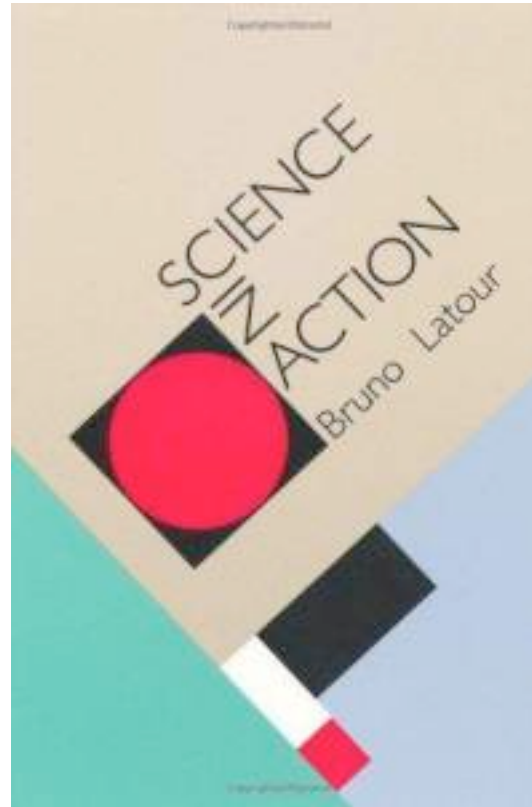

“long, heterogeneous list of resources and allies that scientists... gather... to make dissent impossible”

-> Q: How difficult is it, in practice, to modify established knowledge & practices?

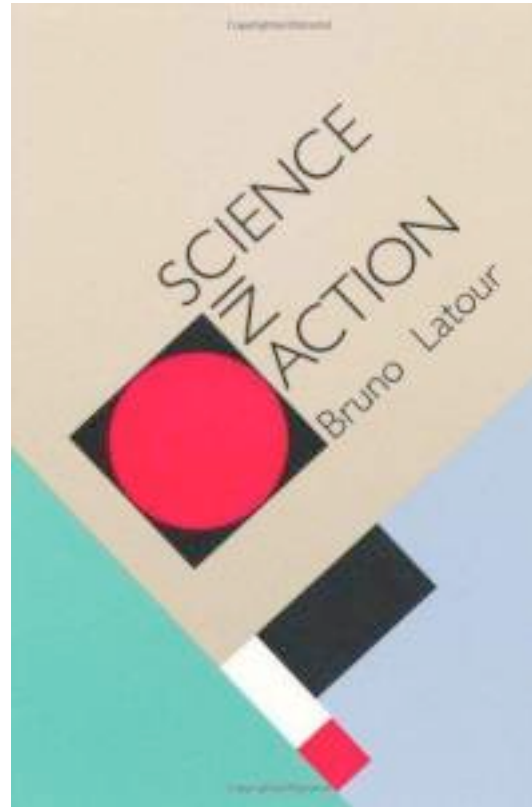

-> 1. Humans, other living & non-living things
all resist being mobilized (ANT)

vs.

2. Reflexive, embedded, self-conscious human
modifiers

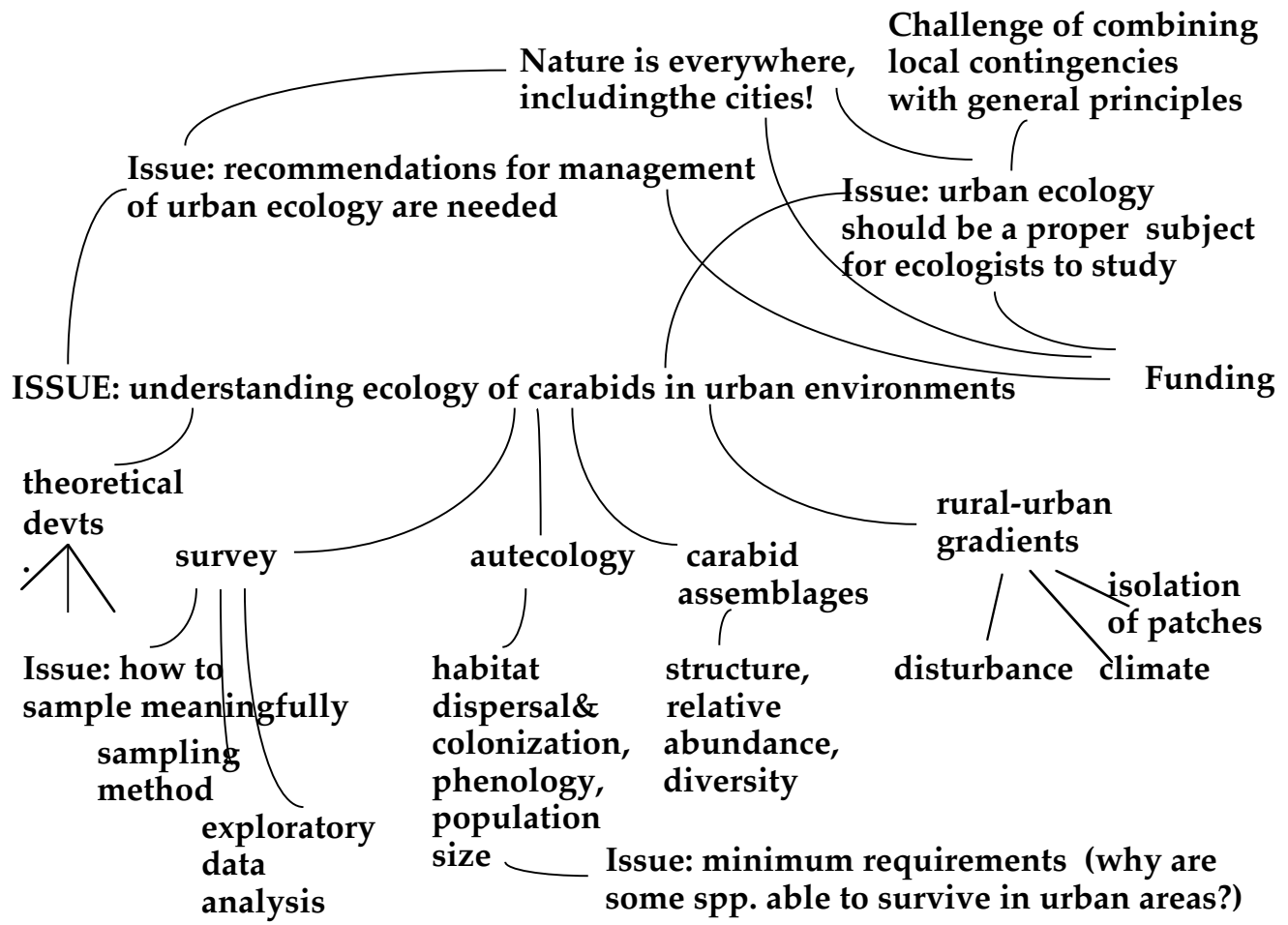

**“no longer possible to simply continue along
previous lines”**

“no longer possible to simply continue along previous lines”

Flexible engagement

participants in any knowledge-making situation
connect quickly with others who are almost
ready to foster participatory processes
&, through the experience such processes
provide their participants,
contribute to enhancing the capacity of others
to do likewise.

WEST NIPISSING VISION

STRONG DIVERSIFIED ECONOMIC BASE			EXCITING ATTRACTIVE COMMUNITY TO LIVE IN			ACTIVELY INVOLVED POPULATION		
WIDELY PROMOTED TOURISM BASE	EXPANDED BUSINESS DEVELOPMENT	APPROPRIATE NATURAL RESOURCES DEVELOPMENT	WELL MAINTAINED EXPANDING INFRA-STRUCTURE	COMMUNITY BASED SERVICES	RESPONSIVE ACCOUNTABLE UNIFIED GOVERNMENT	ACTIVE INVOLVED COMMUNITY	IMPROVED RECREATION OPPORTUNITY	LIFELONG EDUCATION FACILITIES
Broad Based Tourism Promotion	Modern Recycling Facilities	Forestry Development	Improved Transportation Network Locally/Area	First Response Teams	Effective Cooperation Between Municipalities	Active Involvement of Citizens in All Community Developments	Youth Activities Promoted and Supported	Accessible Expanded Adult Education
Improved Four Season Accommodation	Northern Ontario Service Industry Centre	Expanded Local Agricultural Market		Community Based Services for Mental Health & Physically Challenged				
	Appropriate Natural & Resource Based Industry		Well Serviced Community	Expanded Local Access to Specialized Clinics	Local Service Boards in Unincorporated Municipalities	West Nipissing Friendly Welcoming Community	Broadened Leisure Activities and Facilities	
Accessible Waterways and Waterfronts	Incentive Programs to Attract Businesses	Fish Hatcheries		Environmentally Responsive Community		Coordinated Integrated Services under One Roof		Re-evaluate Land Use By-laws
Packaged Tourist Attractions & Tours	Francophone Bilingual College	Clean Lake Nipissing	Expanded Vibrant Senior Citizen Community		Restructured Social Assistance System	Open Communication across West Nipissing	Improved Organized Sports	
Expanded Coordinated Community Festivals	Local Businesses meet all needs		Attract Government Offices					Youth Involved in Planning All Activities

Gripped by uncertainty: Sturgeon Falls springs into action following the closure of its primary employer.

Print

Author: Haddow, Scott Hunter

Date: Jan 1, 2003

Words: 942

Publication: Northern Ontario Business

ISSN: 0710-2755

Sturgeon Falls is again facing the job loss blitzkrieg that is sweeping across Northern Ontario. Weyerhaeuser closed their containerboard mill in Sturgeon Falls on Dec. 5. The closure affected 140 workers and an entire community.

"It translates into a major financial loss to the municipality," says Gary O'Connor, mayor of Sturgeon Falls.

transversal engagement

practice and policy

- takes seriously the creativity & capacity-building from well-facilitated participation among people who share a place or livelihood
- mitigates adverse trans-local decisions
- incorporates knowledge-making of non-local or trans-local researchers—including their analyses of abstracted dynamics of political-economic change

**“most workshops are dysfunctional.
This one wasn’t”**

**evaluations
New England Workshop on
Science & Social Change
2004**

New England Workshop on Science & Social Change

Topics have included

- social shaping of the use of genetic knowledge
- complexities of genes-environment-development
- social implications of ecological restoration
- collaborative generation of environmental knowledge and inquiry
- heterogeneity in biosocial development
- teaching and public engagement beyond disciplinary boundaries
- collaborative production of knowledge: health, environment, and publics (Portugal)

upcoming: troubled by heterogeneity? (at CES in November)

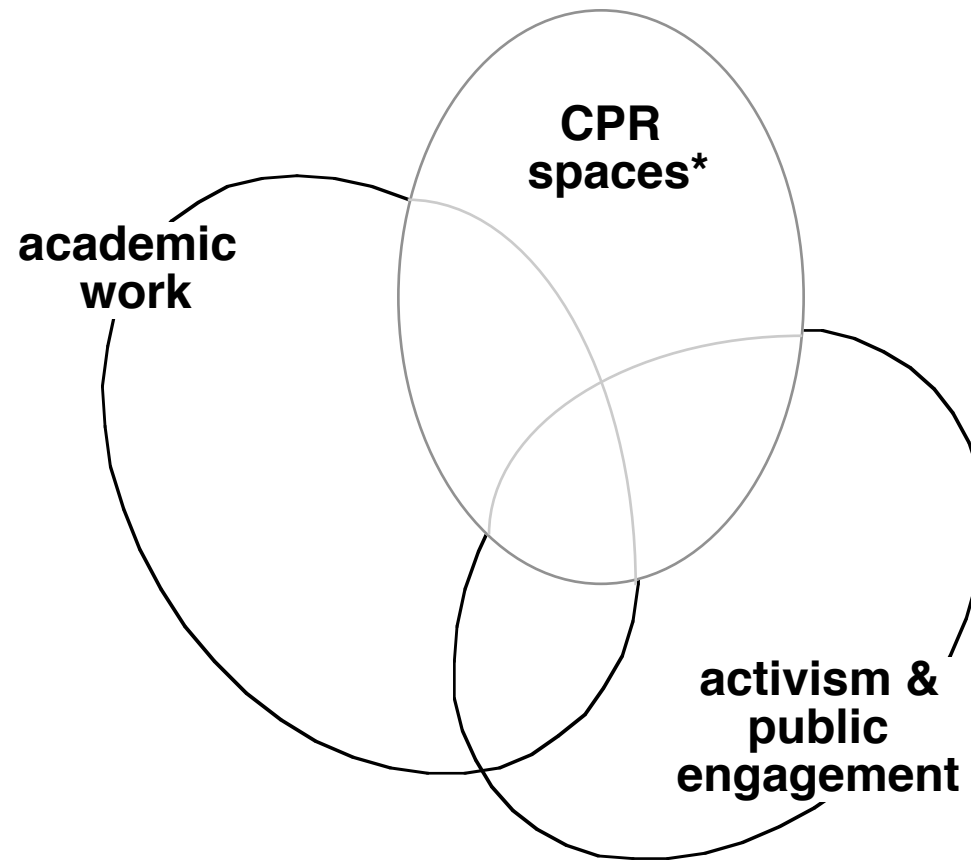

* Connecting, Probing, Reflecting

CPR spaces

emphasizing the value of
discussion, reflection & clarifying
one's identity and affinities
with academic and action/engagement dimensions
kept in view

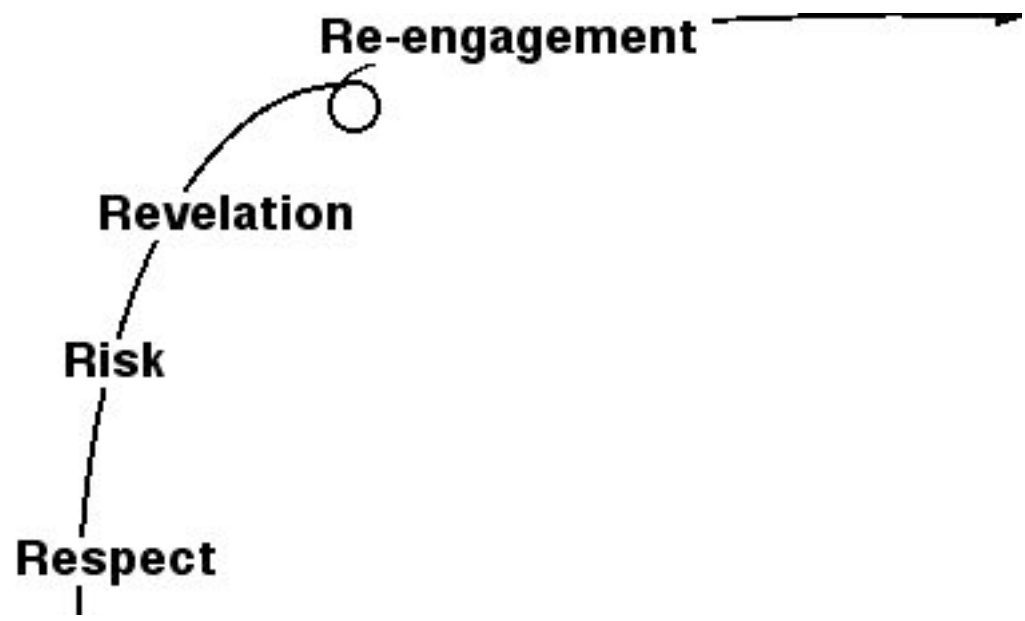

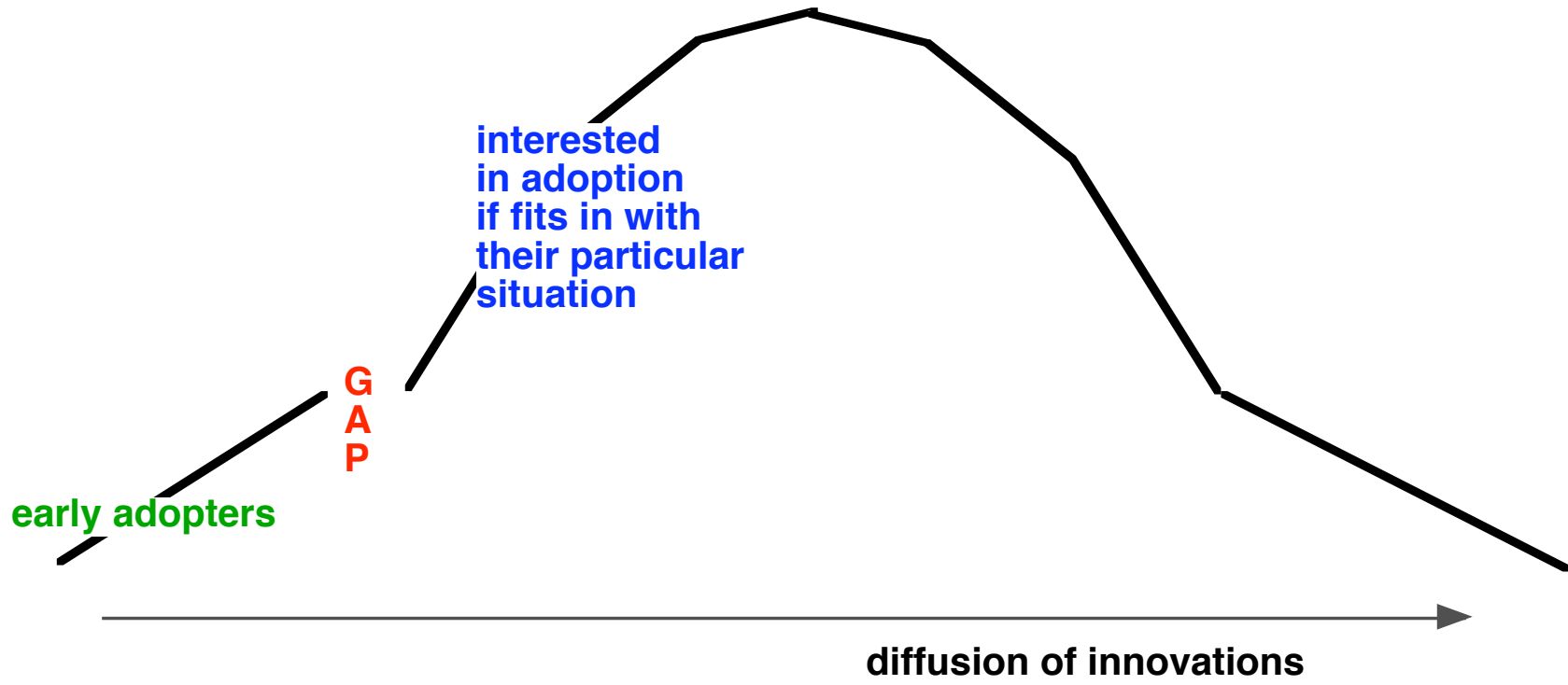

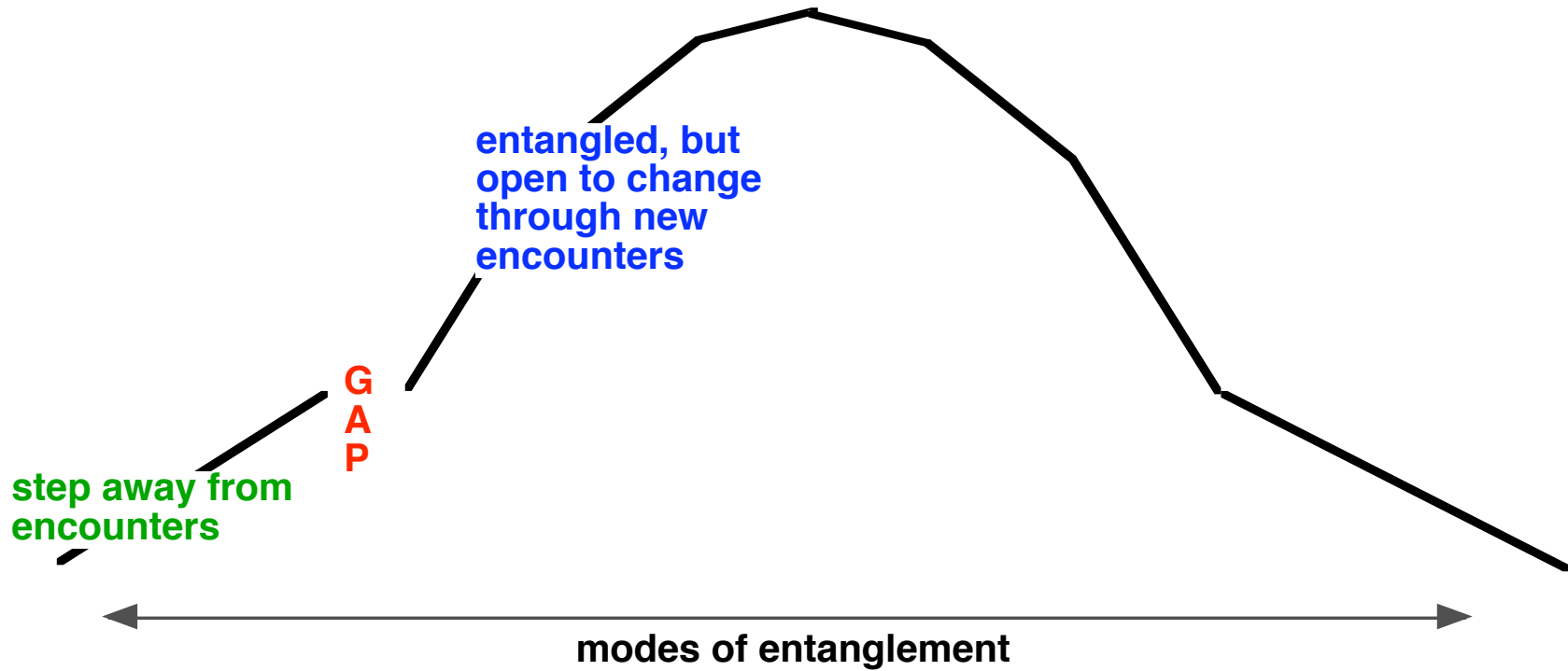

*How can we reduce our
vulnerability to staying too
long with our chosen path of
research?*

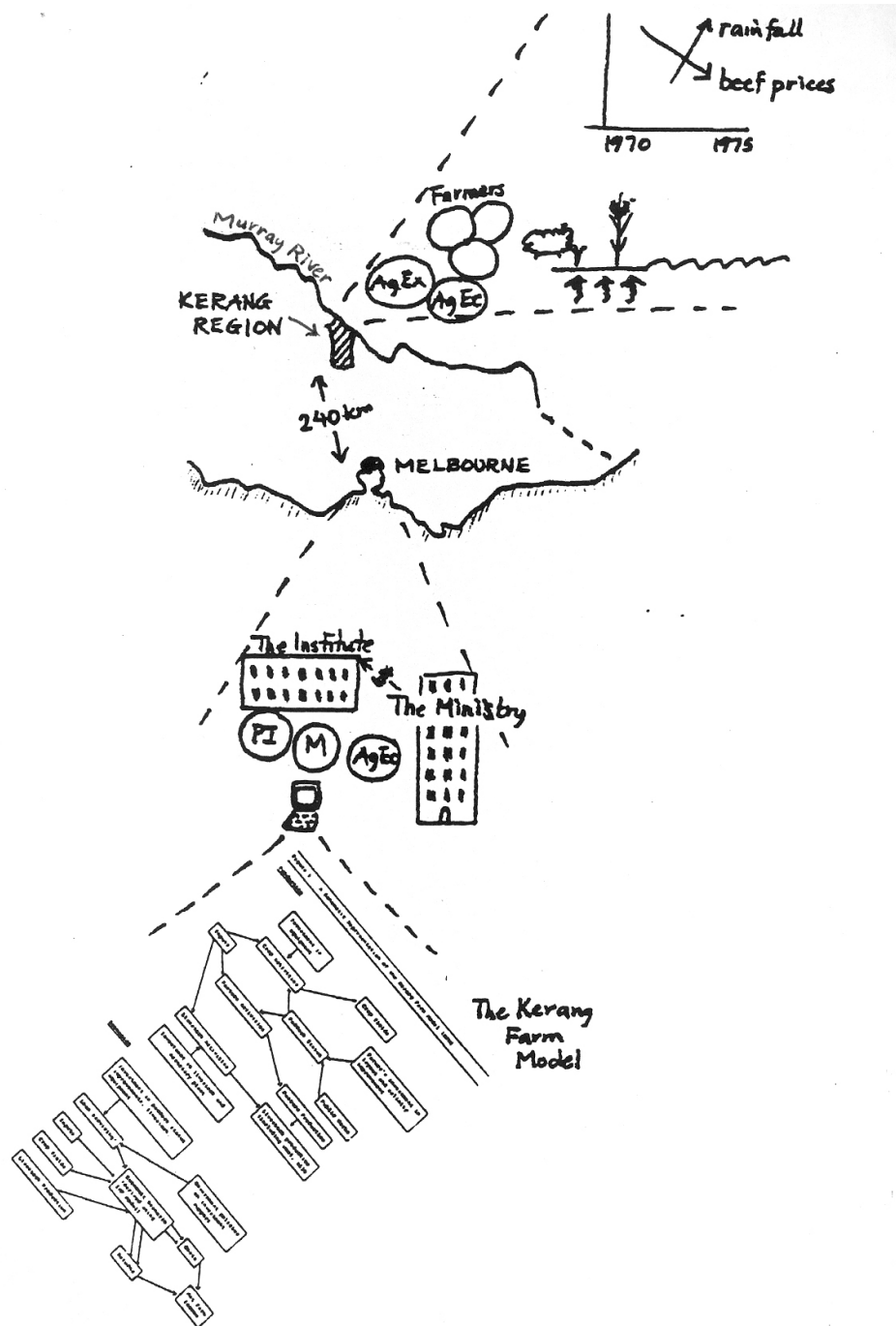

“If I had stayed longer in the area, I may have connected with a range of change agents”

*How can we reduce our
vulnerability to leaving a path
of research too quickly?*

Peter J. Taylor

Unruly Complexity

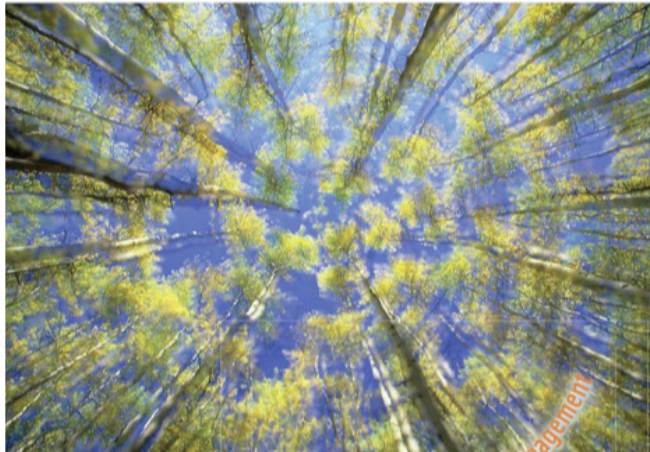

Ecology, Interpretation, Engagement

Unruly Complexity

PETER J. TAYLOR

CHICAGO



TAKING YOURSELF SERIOUSLY

Processes of Research and Engagement

Peter J. Taylor and Jeremy Szteiter

refractive practice

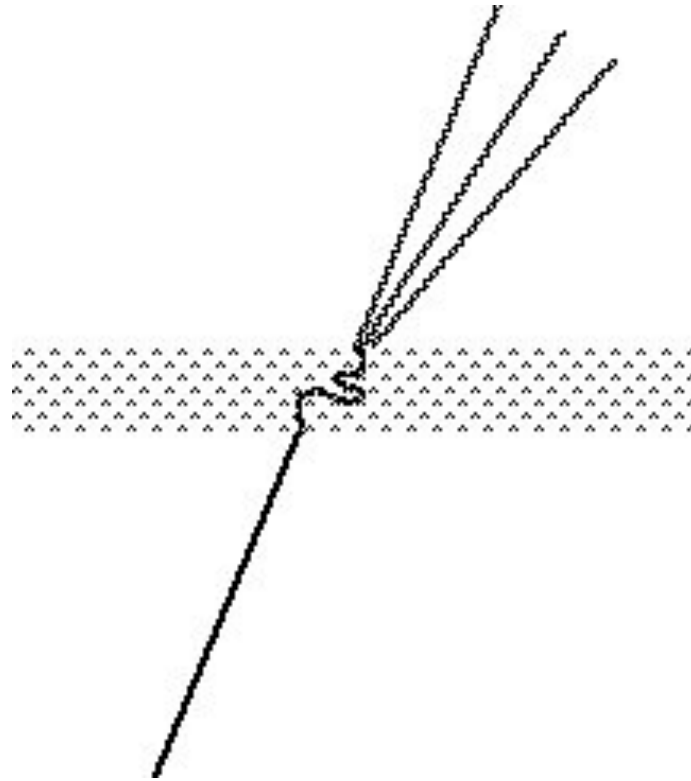

Plus-Delta feedback:

On a strip of paper, note: +) one thing you appreciated from the presentation & Δ) one thing that needs to be developed further (by the speaker or by you)